

**İç ve Dış Bükey Dönüşler**  
Vertical Inside & Outside Bends

Sipariş Kodu Order Code	a Genişlik Width (mm)	h Yükseklik Height (mm)	e Kalınlık Thickness (mm)	Ağırlık Weight (kg/ad)
KRC050AID4015	50	40	1.5	0.854
KRC100AID4015	100	40	1.5	1.148
KRC150AID4015	150	40	1.5	1.442
KRC200AID4015	200	40	1.5	1.737
KRC250AID4015	250	40	1.5	2.031
KRC300AID4020	300	40	2	3.101
KRC400AID4020	400	40	2	3.886
KRC500AID4020	500	40	2	4.671
KRC600AID4020	600	40	2	5.456

KRC200AID4015

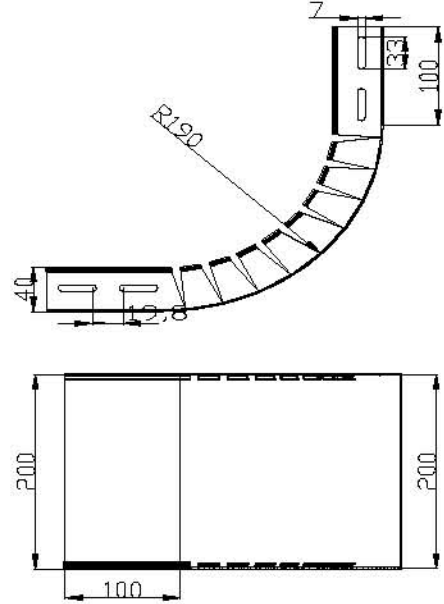
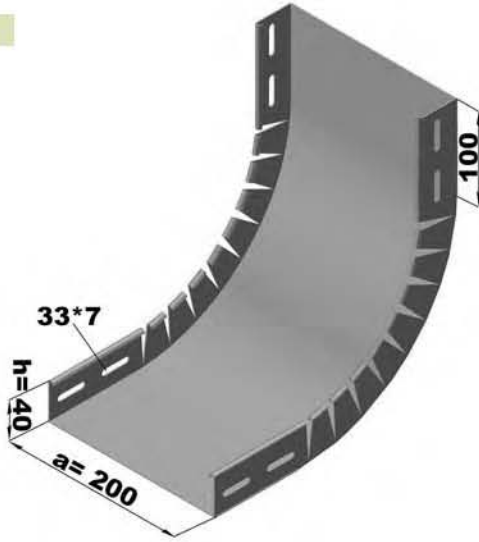

Sipariş Kodu Order Code	a Genişlik Width (mm)	h Yükseklik Height (mm)	e Kalınlık Thickness (mm)	Ağırlık Weight (kg/ad)
KRC050AID6015	50	60	1.5	1.089
KRC100AID6015	100	60	1.5	1.325
KRC150AID6015	150	60	1.5	1.678
KRC200AID6015	200	60	1.5	1.972
KRC250AID6015	250	60	1.5	2.267
KRC300AID6020	300	60	2	3.415
KRC400AID6020	400	60	2	4.200
KRC500AID6020	500	60	2	4.985
KRC600AID6020	600	60	2	5.770

KRC200AID6015

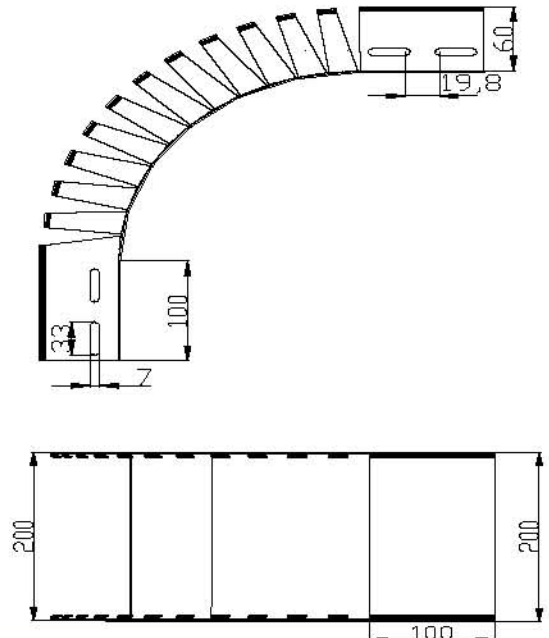
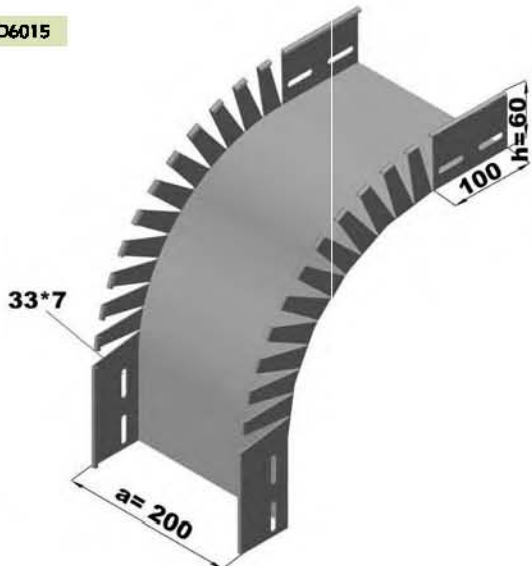

## İç ve Dış Bükey Dönüşler Vertical Inside & Outside Bends

Sipariş Kodu Order Code	a Geniçlik Width (mm)	h Yükseklik Height (mm)	e Kalınlık Thickness (mm)	Ağırlık Weight (kg/ad)
KRC100AID10015	100	100	1.5	1.855
KRC150AID10015	150	100	1.5	2.149
KRC200AID10015	200	100	1.5	2.443
KRC250AID10015	250	100	1.5	2.738
KRC300AID10020	300	100	2	4.043
KRC400AID10020	400	100	2	4.828
KRC500AID10020	500	100	2	5.613
KRC600AID10020	600	100	2	5.398

KRC200AID10015

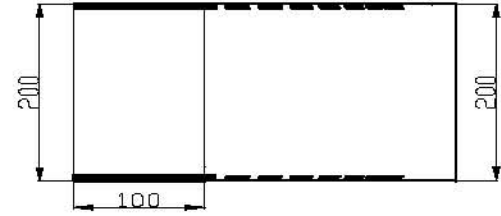
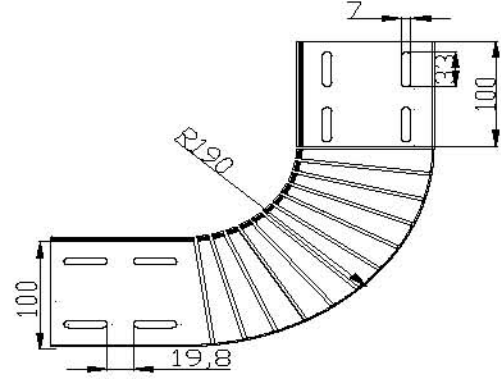
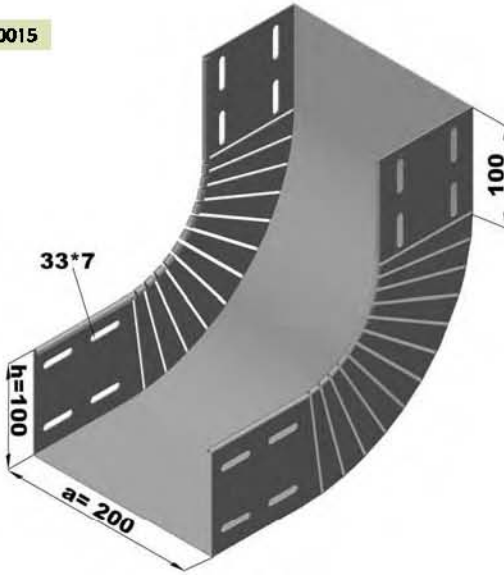

## İç ve Dış Bükey Dönüş Kapakları Vertical Inside & Outside Bend Covers

Sipariş Kodu Order Code	a Geniçlik Width (mm)	h Yükseklik Height (mm)	e Kalınlık Thickness (mm)	Ağırlık Weight (kg/ad)
KRC050AIDK1315	50	13	1.5	0.530
KRC100AIDK1315	100	13	1.5	0.833
KRC150AIDK1315	150	13	1.5	1.236
KRC200AIDK1315	200	13	1.5	1.590
KRC250AIDK1315	250	13	1.5	1.940
KRC300AIDK1320	300	13	2	3.062
KRC400AIDK1320	400	13	2	4.004
KRC500AIDK1320	500	13	2	4.946
KRC600AIDK1320	600	13	2	5.088

KRC200AIDK1315

