

Ağır Hizmet Tipi Kablo Kanalları Heavy Duty Type Cable Trays

Sipariş Kodu Order Code	a Geniçlik Width (mm)	h Yükseklik Height (mm)	e Kalınlık Thickness (mm)	l Uzunluk Length (mm)	Ağırlık Weight (kg/m)
KRC050A4010	50	40	1	3000	1.047
KRC100A4010	100	40	1	3000	1.409
KRC100A4015	100	40	1.5	3000	2.112
KRC150A4010	150	40	1	3000	1.770
KRC150A4015	150	40	1.5	3000	2.694
KRC200A4010	200	40	1	3000	2.130
KRC200A4012	200	40	1.2	3000	2.557
KRC200A4015	200	40	1.5	3000	3.196
KRC250A4015	250	40	1.5	3000	3.730
KRC250A4020	250	40	2	3000	4.984
KRC300A4015	300	40	1.5	3000	4.279
KRC300A4020	300	40	2	3000	5.701
KRC400A4015	400	40	1.5	3000	5.363
KRC400A4020	400	40	2	3000	7.150
KRC500A4015	500	40	1.5	3000	6.445
KRC500A4020	500	40	2	3000	8.595
KRC600A4015	600	40	1.5	3000	7.538
KRC600A4020	600	40	2	3000	10.040

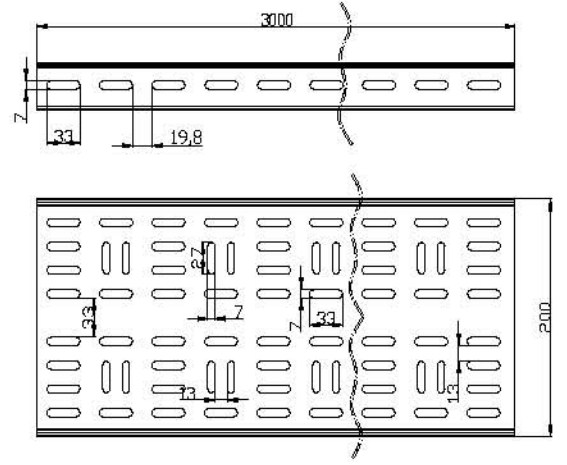

KRC200A4015

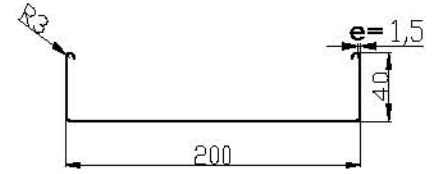
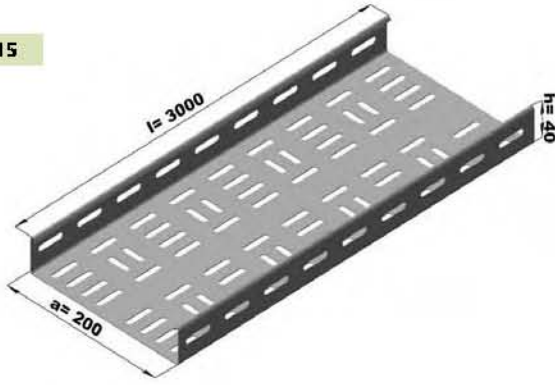

Sipariş Kodu Order Code	a Geniçlik Width (mm)	h Yükseklik Height (mm)	e Kalınlık Thickness (mm)	l Uzunluk Length (mm)	Ağırlık Weight (kg/m)
KRC050A6010	50	60	1	3000	1.336
KRC100A6010	100	60	1	3000	1.625
KRC100A6015	100	60	1.5	3000	2.546
KRC150A6010	150	60	1	3000	2.058
KRC150A6015	150	60	1.5	3000	3.070
KRC200A6010	200	60	1	3000	2.420
KRC200A6012	200	60	1.2	3000	2.904
KRC200A6015	200	60	1.5	3000	3.630
KRC250A6015	250	60	1.5	3000	4.170
KRC250A6020	250	60	2	3000	5.562
KRC300A6015	300	60	1.5	3000	4.712
KRC300A6020	300	60	2	3000	6.284
KRC400A6015	400	60	1.5	3000	5.796
KRC400A6020	400	60	2	3000	7.728
KRC500A6015	500	60	1.5	3000	6.879
KRC500A6020	500	60	2	3000	9.173
KRC600A6015	600	60	1.5	3000	7.963
KRC600A6020	600	60	2	3000	10.617

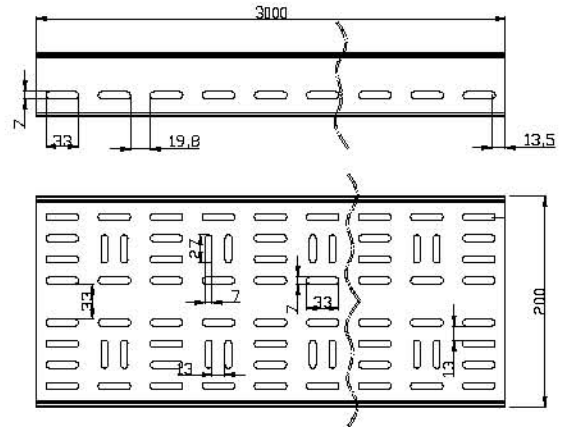

KRC200A6015

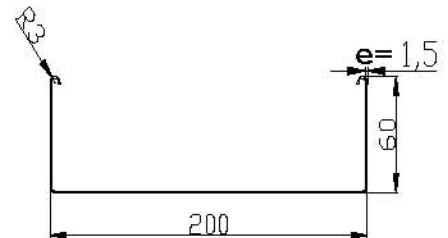
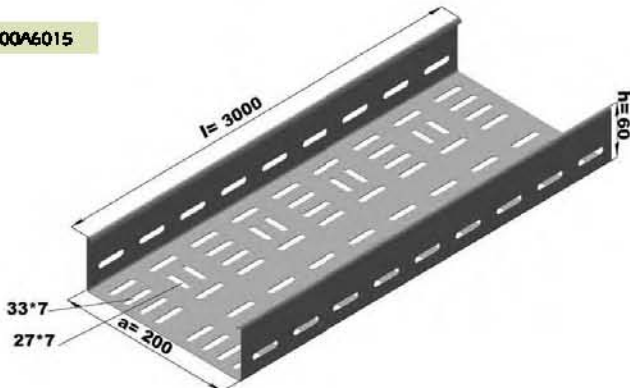

Ağır Hizmet Tipi Kablo Kanalları Heavy Duty Type Cable Trays

Sipariş Kodu Order Code	a Geniçlik Width (mm)	h Yükseklik Height (mm)	e Kalınlık Thickness (mm)	l Uzunluk Length (mm)	Ağırlık Weight (kg/m)
KRC100A10010	100	100	1	3000	2.275
KRC100A10015	100	100	1.5	3000	3.412
KRC150A10010	150	100	1	3000	2.636
KRC150A10015	150	100	1.5	3000	3.995
KRC200A10012	200	100	1.2	3000	3.596
KRC200A10015	200	100	1.5	3000	4.496
KRC250A10015	250	100	1.5	3000	5.037
KRC250A10020	250	100	2	3000	6.717
KRC300A10015	300	100	1.5	3000	5.578
KRC300A10020	300	100	2	3000	7.439
KRC400A10015	400	100	1.5	3000	6.663
KRC400A10020	400	100	2	3000	8.884
KRC500A10015	500	100	1.5	3000	7.745
KRC500A10020	500	100	2	3000	10.328
KRC600A10015	600	100	1.5	3000	8.829
KRC600A10020	600	100	2	3000	11.938

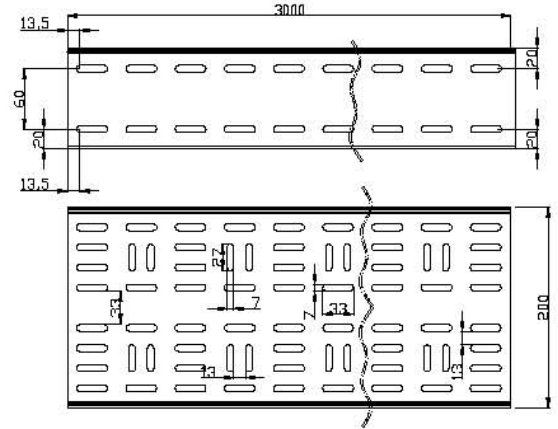

KRC200A10015

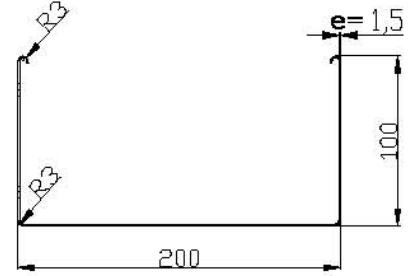
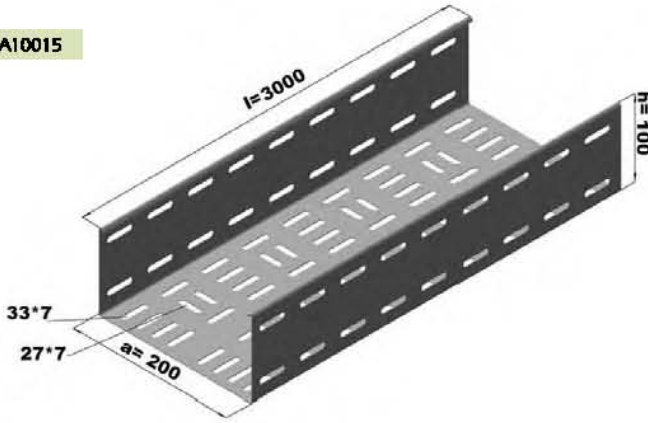

Ağır Hizmet Tipi Deliksiz Kablo Kanalları Heavy Duty Type Cable Trays Without Holes

Sipariş Kodu Order Code	a Geniçlik Width (mm)	h Yükseklik Height (mm)	e Kalınlık Thickness (mm)	l Uzunluk Length (mm)	Ağırlık Weight (kg/m)
KRC050A4010K	50	40	1	3000	1.138
KRC100A4010K	100	40	1	3000	1.531
KRC100A4015K	100	40	1.5	3000	2.296
KRC150A4010K	150	40	1	3000	1.923
KRC150A4015K	150	40	1.5	3000	2.885
KRC200A4010K	200	40	1	3000	2.315
KRC200A4012K	200	40	1.2	3000	2.779
KRC200A4015K	200	40	1.5	3000	3.474
KRC250A4015K	250	40	1.5	3000	4.062
KRC250A4020K	250	40	2	3000	5.417
KRC300A4015K	300	40	1.5	3000	4.651
KRC300A4020K	300	40	2	3000	6.202
KRC400A4015K	400	40	1.5	3000	5.829
KRC400A4020K	400	40	2	3000	7.772
KRC500A4015K	500	40	1.5	3000	7.006
KRC500A4020K	500	40	2	3000	9.342
KRC600A4015K	600	40	1.5	3000	8.184
KRC600A4020K	600	40	2	3000	10.912

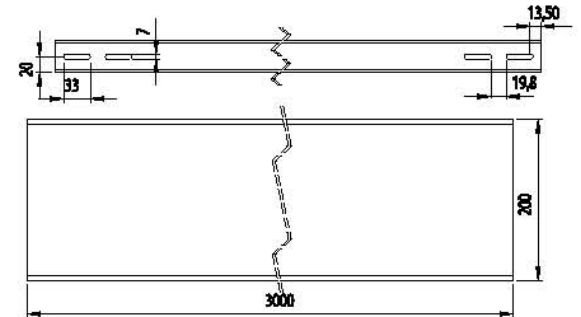

KRC200A4015K

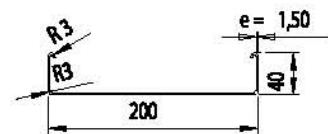
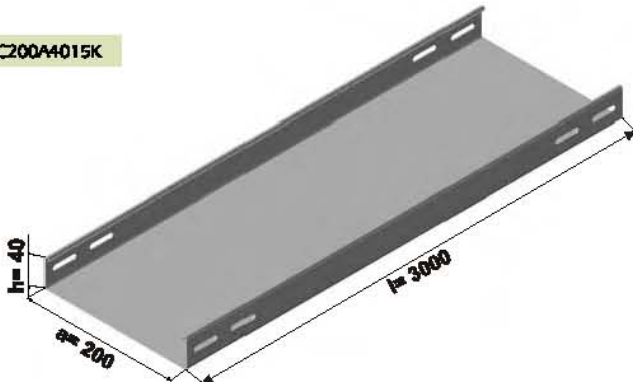

Ağır Hizmet Tipi Deliksiz Kablo Kanalları Heavy Duty Type Cable Trays Without Holes

Sipariş Kodu Order Code	a Geniçlik Width (mm)	h Yükseklik Height (mm)	e Kalınlık Thickness (mm)	l Uzunluk Length (mm)	Ağırlık Weight (kg/m)
KRC050A6010K	50	60	1	3000	1.452
KRC100A6010K	100	60	1	3000	1.766
KRC100A6015K	100	60	1.5	3000	2.767
KRC150A6010K	150	60	1	3000	2.237
KRC150A6015K	150	60	1.5	3000	3.356
KRC200A6010K	200	60	1	3000	2.630
KRC200A6012K	200	60	1.2	3000	3.156
KRC200A6015K	200	60	1.5	3000	3.945
KRC250A6015K	250	60	1.5	3000	4.533
KRC250A6020K	250	60	2	3000	6.045
KRC300A6015K	300	60	1.5	3000	5.122
KRC300A6020K	300	60	2	3000	6.830
KRC400A6015K	400	60	1.5	3000	6.300
KRC400A6020K	400	60	2	3000	8.400
KRC500A6015K	500	60	1.5	3000	7.477
KRC500A6020K	500	60	2	3000	9.970
KRC600A6015K	600	60	1.5	3000	8.655
KRC600A6020K	600	60	2	3000	11.540

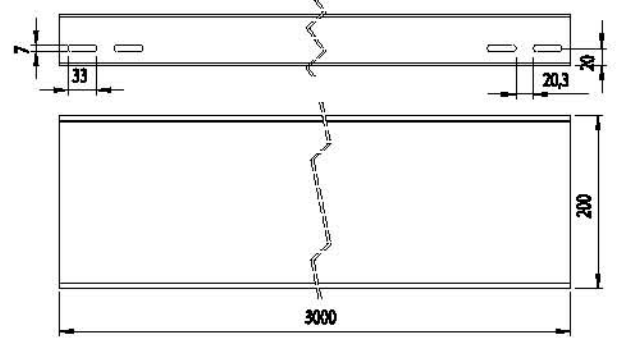

KRC200A6015K

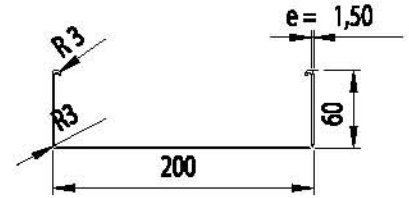
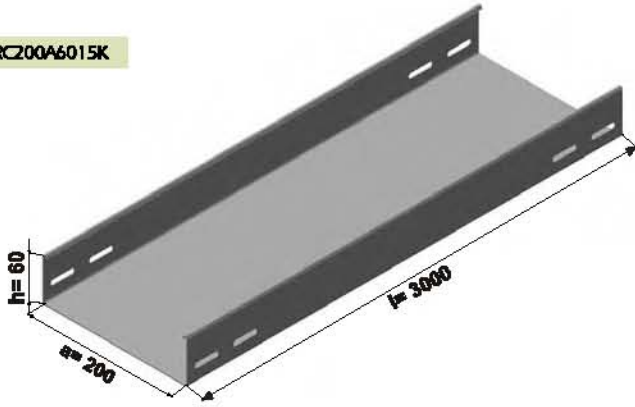

Sipariş Kodu Order Code	a Geniçlik Width (mm)	h Yükseklik Height (mm)	e Kalınlık Thickness (mm)	l Uzunluk Length (mm)	Ağırlık Weight (kg/m)
KRC100A10010K	100	100	1	3000	2.473
KRC100A10015K	100	100	1.5	3000	3.709
KRC150A10010K	150	100	1	3000	2.865
KRC150A10015K	150	100	1.5	3000	4.298
KRC200A10012K	200	100	1.2	3000	3.909
KRC200A10015K	200	100	1.5	3000	4.887
KRC250A10015K	250	100	1.5	3000	5.475
KRC250A10020K	250	100	2	3000	7.301
KRC300A10015K	300	100	1.5	3000	6.064
KRC300A10020K	300	100	2	3000	8.086
KRC400A10015K	400	100	1.5	3000	7.242
KRC400A10020K	400	100	2	3000	9.656
KRC500A10015K	500	100	1.5	3000	8.419
KRC500A10020K	500	100	2	3000	11.226
KRC600A10015K	600	100	1.5	3000	9.597
KRC600A10020K	600	100	2	3000	12.976

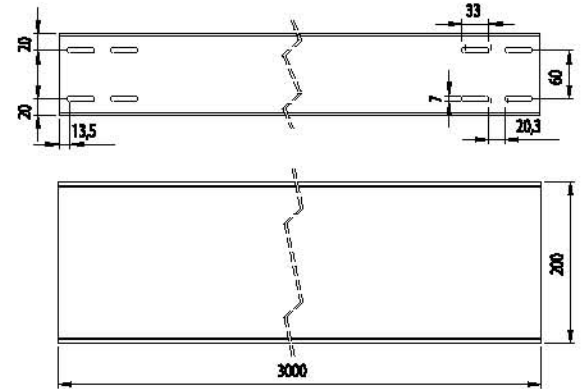

KRC200A10015K

